

# 8080-1G Series *TO-3 Power Transistor Sockets*



8080-1G7

## FEATURES:

The 8080-1G family of TO-3 Power Transistor Sockets is used for both small and large signal devices. Used in power supplies, power amplifiers, sweep amplifiers, and machine controlled equipment. These sockets are designed to constantly perform.

- Contact rating 10 amps. 20 Amps for 8080-1G44 VDE style
- Sockets accept components with .040 (1,02) .002 -.003 (+0,05 -0,08) diameter lead or .060 (1,52) +.002 -.003 (+0,05 -0,08) diameter leads
- Integral mounting saddle has 20 inch pounds min. thread strength
- Diallyl phthalate and phenolic insulators

## MATERIAL SPECIFICATIONS:

Insulator ..... Black phenolic or green diallyl phthalate,  
UL rated 94V-0  
Mounting Saddle ..... Brass, heat treated  
Saddle Plating ..... Electro-tin  
Insulating Washer ..... Mica .003 (0,08) thick  
Ordered separately-part number 8038-3P1, Fig. 2  
Contacts ..... Beryllium copper  
Contact Plating ..... Tin, silver or gold

## PERFORMANCE SPECIFICATIONS:

### MECHANICAL

Vibration ..... 10 - 2,000 Hz, MIL-STD-202, Method 204,  
Condition B, transistor installed  
Durability ..... 50 Insertions per MIL-STD-12883  
Insertion Force ..... 6 Pounds max. per MIL-STD-12883  
Withdrawal Force ..... 18 Pounds min., 6 pounds max. per  
MIL-STD-12883  
Thread Strength ..... 20 Inch pounds minimum

### ELECTRICAL

Bulk Resistance ..... Gold 15 milliohms, per MIL-STD-12883  
Tin 25 milliohms max.  
Silver 25 milliohms max.  
Current Rating ..... 10 Amps DC  
Insulation Resistance .... 1,000 Megohms per MIL-STD-202  
Dielectric Withstanding  
Voltage ..... 1,500 Volts RMS

### ENVIRONMENTAL

Operating Temperature .. -55°C to +125°C.  
Mechanical Shock ..... Passed MIL-STD-12833, with transistor inserted  
at test gage

H

**Thomas & Betts**

Quality & Innovation From **AUGAT**® Name Brand Products

H20

Thomas & Betts  
1555 Lynnfield Road  
Memphis, TN 38119  
(901) 682-8221 FAX (901) 537-8805

# T0-3 Power Transistor Sockets 8080-1G Series

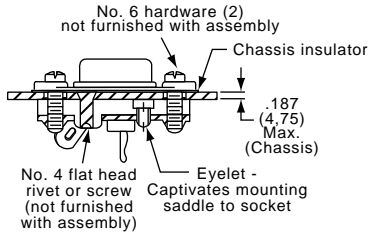

Figure 1

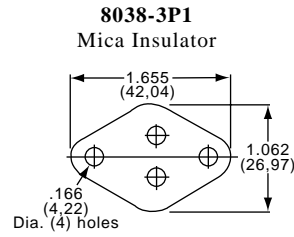
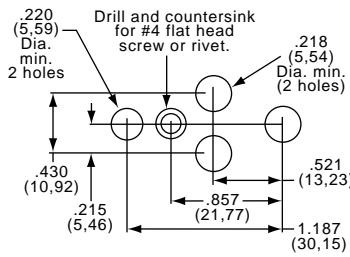

Figure 2

## Recommended Chassis Cutout Standard



## Recommended Chassis Cutout 8080-1G17 and 8080-1G45

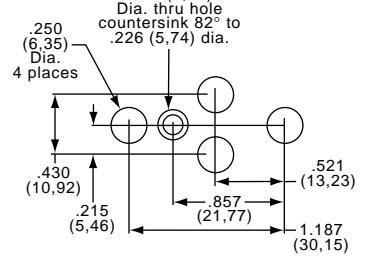

Figure 3

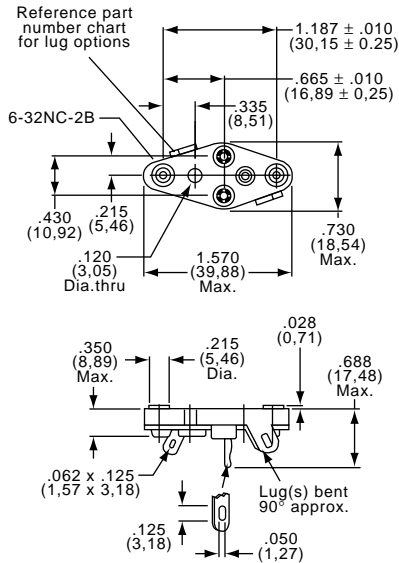

Figure 4

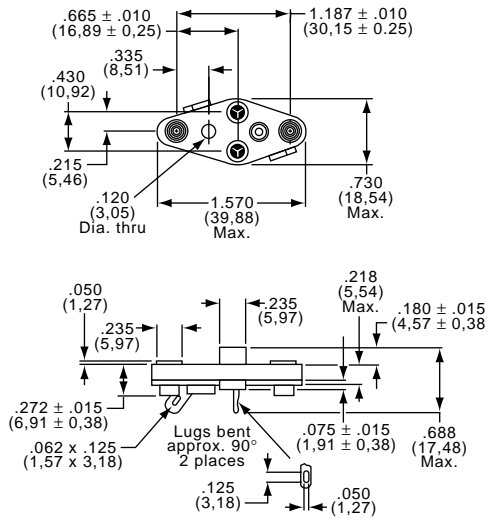

Figure 5

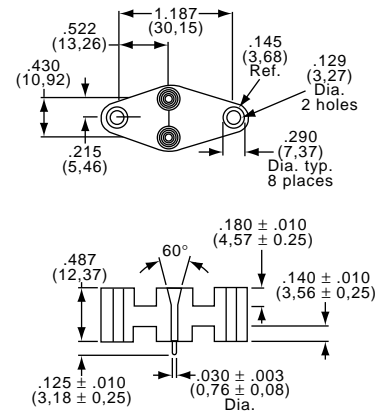

Figure 6

## PART NUMBER / STANDARD CONFIGURATIONS

.040 Diameter Pin				
Part Number	Insulator	Contact Plating	Solder Lugs	Figure
8080-1G1	Phenolic	Electro-Tin		4
8080-1G45				5
8080-1G13	Diallyl Phthalate	Silver	Two Solder Lugs	4
8080-1G27	Phenolic			
8080-1G2	Diallyl Phthalate			
8080-1G7	Phenolic			
8080-1G10	Diallyl Phthalate	Gold		4
8080-1G3	Phenolic			
8080-1G24	Diallyl Phthalate			
8080-1G29	Phenolic			
8080-1G4	Diallyl Phthalate	Silver	One Solder Lug	4
8080-1G9	Phenolic			
8080-1G25	Diallyl Phthalate			
8080-1G44	Thermoplastic Polyester	Gold/Tin/Lead	P.C. Mount	

## PART NUMBER / STANDARD CONFIGURATIONS

.060 Diameter Pin				
Part Number	Insulator	Contact Plating	Solder Lugs	Figure
8080-1G15	Phenolic	Electro-Tin		4
8080-1G17				5
8080-1G31	Diallyl Phthalate	Silver	Two Solder Lugs	4
8080-1G32	Phenolic			
8080-1G16	Diallyl Phthalate			
8080-1G33	Phenolic			
8080-1G34	Diallyl Phthalate	Gold		4
8080-1G20	Phenolic			
8080-1G14	Phenolic			
8080-1G35	Diallyl Phthalate			
8080-1G36	Phenolic	Silver	One Solder Lug	4
8080-1G37	Diallyl Phthalate			
8080-1G38	Phenolic			
8080-1G39	Diallyl Phthalate			

Need more technical information?

Consult your Thomas & Betts sales office listed on the back cover

